

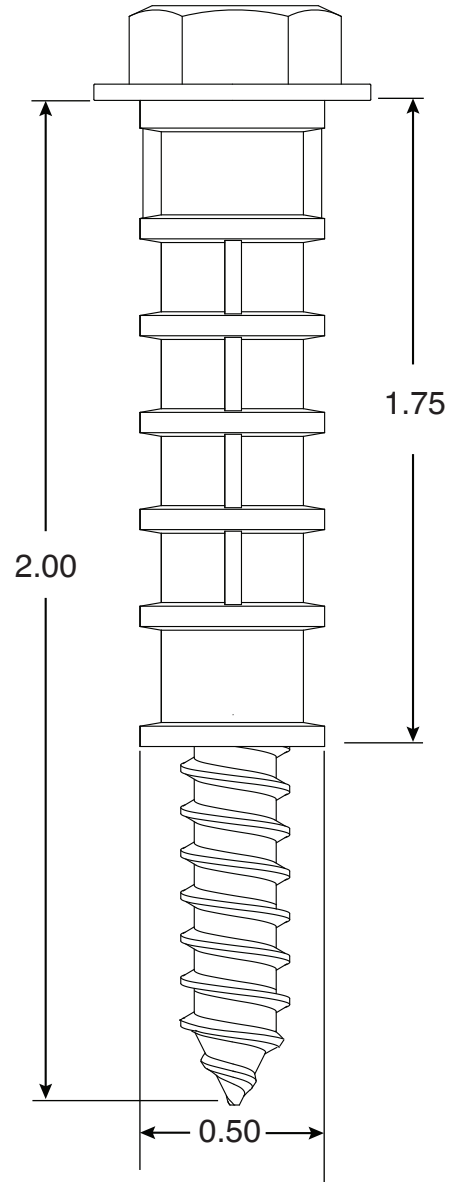

Concrete Anchor Set

Part No.
PF-Wedge

Parts List	
QTY	Description
4	5/16" SS Washer
4	5/16" x 2-1/2" SS Lag Bolt
4	5/16" Long Zinc Lag Shield



- Concrete Anchor Set
- Anchor Set for PF-3119 and PF-25

*Drill Deck 1/2" Dia x 2" Deep

Important - Clear all debris from hole before inserting the lag shield.

Page 1 of 1



Perma-Cast Co. Pueblo, CO
www.permacastonline.com
Call 800-748-2770